















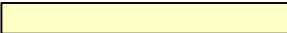

LEGEND

Drainage	 Pit	 Pit/Lintel
Electrical	 Light pole	 Pillar
Communications	 Pit	
Water main	 Hydrant	 Stop Valve
Sewer line	 Maintenance Shaft/Chamber	 Man Hole
Footpath		

Filled area	
Denied access	
Retaining wall	
Easement	
Contour	 100.5
Surface level	 x 95.3

Building And Design Information

Lot Classification	*
Acoustic	*
Salinity	*
Agressivity	*
BAL Rating	*

DESIGN AS BUILT

Fill	✓
Contour	✓

* Information not available at time of publication
NOTE: SERVICES AND RESTRICTIONS SHOWN ON THIS LEGEND MAY NOT BE APPLICABLE TO THIS LOT
DRAWING REFERENCE: 10202T41(DA2S2)-LOT 2258
DATE: 21 December 2023